

GUR-48

48" Undercounter Refrigerator

Glacier undercounter refrigerators incorporate excellence in both form and function. With a spacious interior and brushed stainless steel design, these units embody both durability and a modern style. Recessed door handles ensure comfort and easy cleaning. Additionally, enjoy the versatility of multiple, adjustable and removable wire shelves, providing unparalleled convenience tailored to your needs.



Features

- Coved corners for easy cleaning
- Recessed door handle
- Self-closing doors with 90° stay open feature
- 5" casters with locks on front
- 2 epoxy-coated removable shelves
- 2-year parts and labour warranty
- 5-year compressor warranty

Technical Specifications

- Stainless steel exterior finish
- Stainless steel interior finish
- 115 V/60 Hz
- R290 refrigerant
- Automatic defrost

Optional Features/Accessories

- 3" and 4" casters available for purchase

GUR-48

48" Undercounter Refrigerator

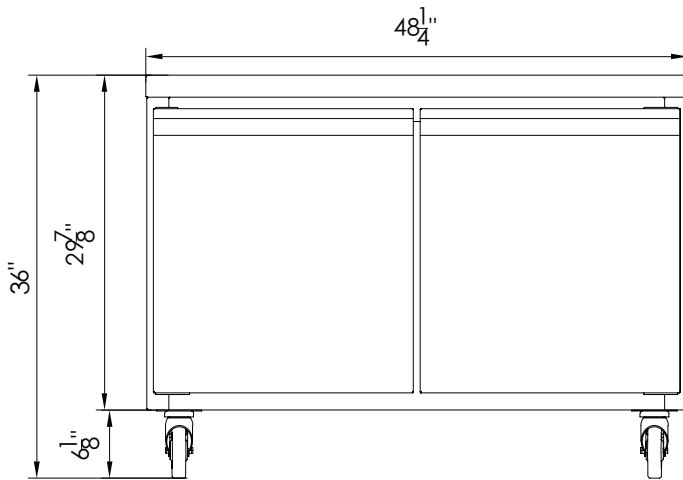

FRONT

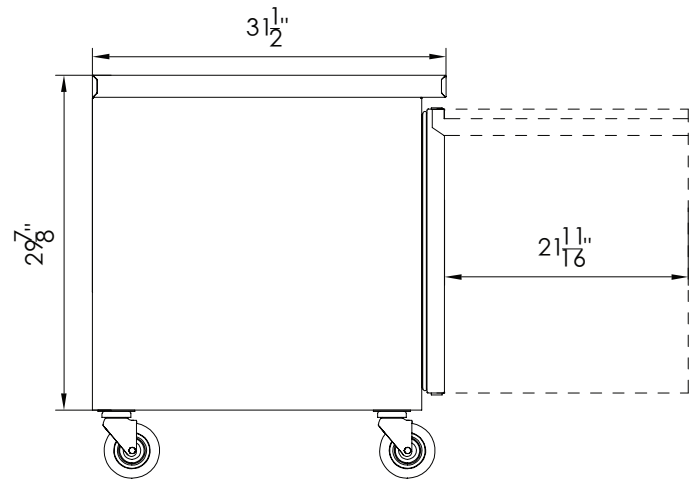

LEFT

Model	External Dimensions (inches)			Crated Dimensions (inches)			Temperature Range °F	Compressor Power (HP)	Net Weight	Gross Weight	# of Shelves	NEMA Config.	Amps
	W	D	H	W	D	H							
GUR-48	48 1/4	31 1/2	36	49 5/8	33 1/8	39 3/8	33 ~ 41°F	1/5	211	267	2	5-15P	2.4

Specifications are subject to change without notice.